

AUTOMATION



Quick Start Guide

UM QS EN nanoLC

Order No.: 2700035

This quick start guide is valid for:
nanoNavigator and nanoLC

General Terms and Conditions of Use for Technical Documentation

Phoenix Contact reserves the right to alter, correct, and/or improve the technical documentation and the products described in the technical documentation at its own discretion and without giving prior notice, insofar as this is reasonable for the user. The same applies to any technical changes that serve the purpose of technical progress.

The receipt of technical documentation (in particular data sheets, installation instructions, manuals, etc.) does not constitute any further duty on the part of Phoenix Contact to furnish information on alterations to products and/or technical documentation. Any other agreement shall only apply if expressly confirmed in writing by Phoenix Contact. Please note that the supplied documentation is product-specific documentation only and that you are responsible for checking the suitability and intended use of the products in your specific application, in particular with regard to observing the applicable standards and regulations.

Although Phoenix Contact makes every effort to ensure that the information content is accurate, up-to-date, and state-of-the-art, technical inaccuracies and/or printing errors in the information cannot be ruled out. Phoenix Contact does not offer any guarantees as to the reliability, accuracy or completeness of the information. All information made available in the technical data is supplied without any accompanying guarantee, whether expressly mentioned, implied or tacitly assumed. This information does not include any guarantees regarding quality, does not describe any fair marketable quality, and does not make any claims as to quality guarantees or guarantees regarding the suitability for a special purpose.

Phoenix Contact accepts no liability or responsibility for errors or omissions in the content of the technical documentation (in particular data sheets, installation instructions, manuals, etc.).

Statement of Legal Authority

This manual, including all illustrations contained herein, is copyright protected. Use of this manual by any third party is forbidden. Reproduction, translation, and public disclosure, as well as electronic and photographic archiving or alteration requires the express written consent of Phoenix Contact. Violators are liable for damages.

Third-party products are always named without reference to patent rights. The existence of such rights shall not be excluded.

Explanation of Symbols Used and Signal Words

The following types of messages provide information about possible property damage and general information concerning proper operation and ease-of-use.



NOTE

This symbol and the accompanying text alerts the reader to a situation which may cause damage or malfunction to the device, either hardware or software, or surrounding property.



This symbol and the accompanying text provides additional information to the reader. It is also used as a reference to other sources of information (manuals, data sheets, literature) on the subject matter, product, etc.

How to contact us

If there are any problems that can't be solved using the documentation, please contact your Phoenix Contact subsidiary. Subsidiary contact information is available at www.phoenixcontact.com.

PHOENIX CONTACT GmbH & Co. KG
Flachsmarkstraße 8
32825 Blomberg
Germany
Phone +49 - (0) 52 35 - 3-00
Fax +49 - (0) 52 35 - 3-4 12 00

Table of Contents

nanoNavigator Sample Program	1-1
Introduction	1-1
Equipment and Preparation	1-2
Creating a Flow Chart	1-5
Running the Project	1-13
Additional Information	1-13

1 nanoNavigator Sample Project

1.1 Introduction

Welcome to the nanoLine Controller Quick Start Guide. This document will guide you through the process of configuring a nanoLine controller (nanoLC) to perform a simple, example application. Several Starter Kits are available that include all the components to simulate this and many other applications.

- Part No. 2701399 provides NPN outputs
- Part No. 2701425 provides PNP outputs
- Part No. 2701467 provides relay outputs

The example application, shown graphically in Figure 1-1, simulates a water tank with a valve to control the flow of water into the tank as the contents are drained out through a separate pipe. The nanoLC monitors the level of the water in the tank through a sensor and opens or closes a valve to keep the water at the proper level.

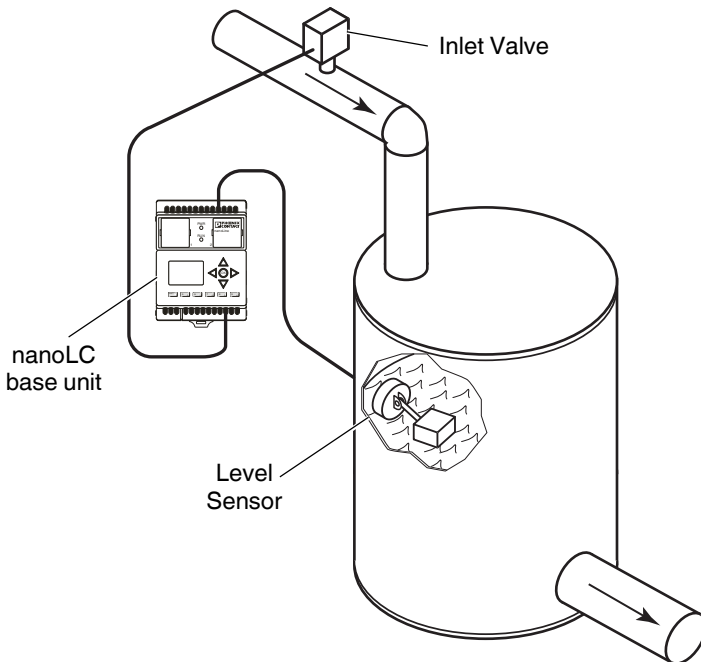

Figure 1-1 Example nanoLC application

This example uses one of the red switches (input) included with the nanoLC starter kit to simulate a sensor in the water tank. When the switch is ON, it will mean that the water is at the proper level and the inlet valve must be turned off. If the switch is OFF, it will mean that the water has drained below the proper level and the inlet valve must be turned on to refill the tank. An LED light (output) will simulate the valve being opened (ON) or closed (OFF). The nanoLC Operator Panel is used to display the status of the valve (ON or OFF). Figure 1-2 below graphically shows the flow of the project logic.

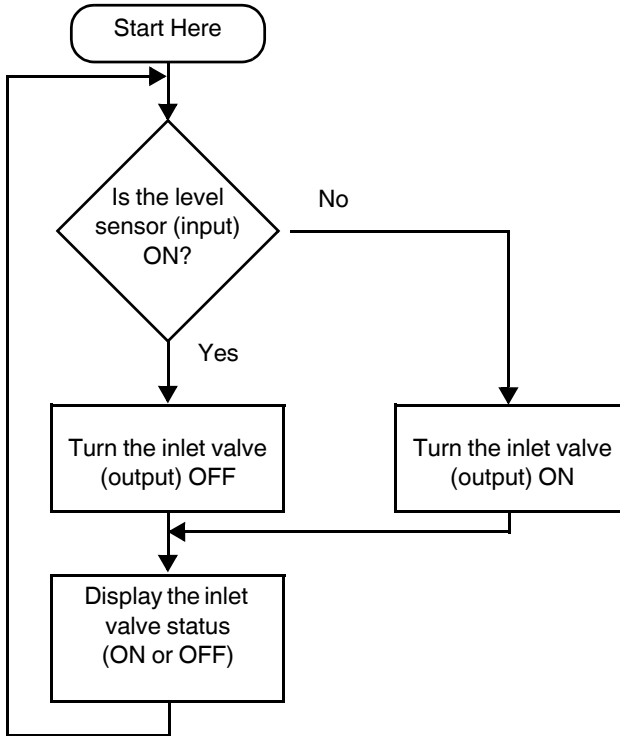

Figure 1-2 Project logic

1.2 Equipment and Preparation

To complete the Quick Start example, the following is required:

- nanoLine starter kit
- 24 V DC output power supply to power the nanoLC
- A personal computer with
 - Operating System: Microsoft® Windows XP® (SP2) or Windows Vista®
 - An available USB port.

1.2.1 Hardware installation

1. Remove the blanks from the base unit and install the nanoLC Operator Panel and USB communication module.



NOTE:

Do not connect the USB cable to the PC until after completing the nanoNavigator software installation, described later in this document.

2. Attach the input switch simulator and output LED simulator modules to the nanoLC terminals as shown in Figure 1-3.
3. Connect 24 V DC power to the nanoLC and simulator modules as shown in Figure 1-3.

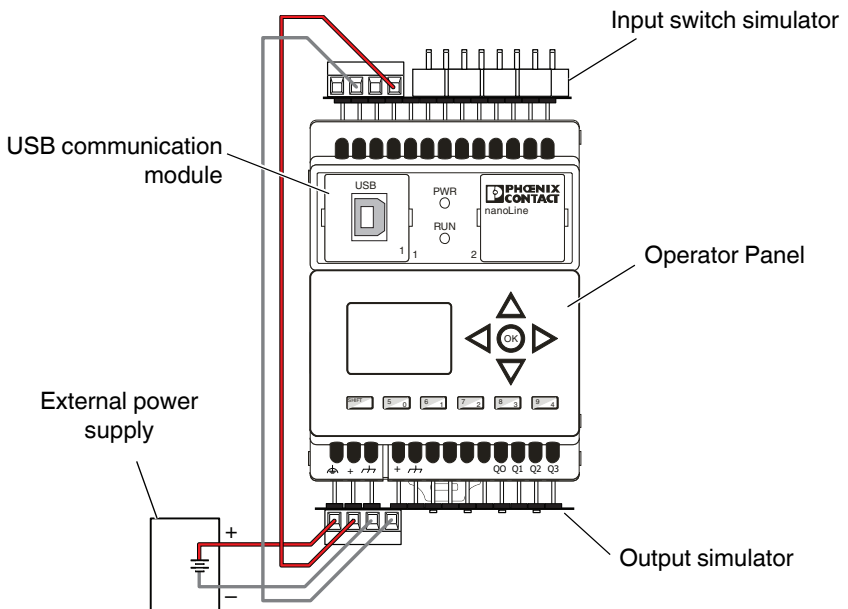

Figure 1-3 nanoLC connections

4. After all connections are made, apply power to the base unit. The nanoLC Power LED should illuminate and the Operator Panel should show status information about the nanoLC. The green power LEDs on the input and output simulator modules should illuminate.

1.2.2 Software installation and connection to the controller

1. Insert the nanoNavigator CD and follow the installation instructions that appear on the screen.
2. Connect the PC to the nanoLC using the USB cable.
3. Click the “Start... All Programs... Phoenix Contact... nanoNavigator” button to open the “nanoNavigator Startup” window (Figure 1-4).



The first time nanoNavigator is started, it may take up to 10 seconds as .NET starts. Do not start a second copy of nanoNavigator during this time.



“Connect to nanoLC” button

Figure 1-4 Opening view of nanoNavigator

4. Click the “Connect to nanoLC” button.

When nanoNavigator connects to the nanoLC, the nanoLC Connection Wizard window appears (Figure 1-5).

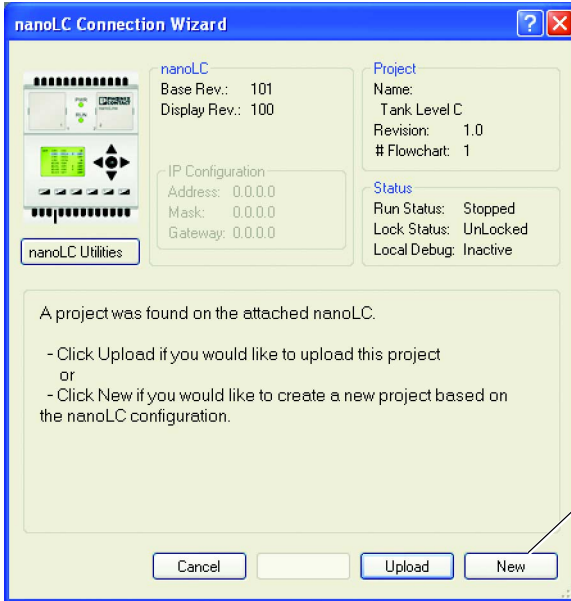

Figure 1-5 nanoLC Connection Wizard



If the nanoLC does not connect automatically, click the “Port” button and select the correct port, for example, COM1, then click on “Next” to connect. The “Port” button does not appear unless a controller is not found.

5. Click the “New” button to start a new project.



Clicking the “New” button while connected to the nanoLine controller causes nanoNavigator to read the hardware configuration of the nanoLC. Additional setup of the nanoLC is not necessary. If not connected to a nanoLC, the controller configuration must be manually selected. Refer to the nanoNavigator User Manual for additional information.

1.3 Creating a Flow Chart

The following steps provide a guide to using the nanoNavigator software to create a flow chart. The flow chart will control the tank water level and display the status of the valve (see Figure 1-1 for a graphical representation of the application).

1.3.1 Cell A1 – Decision Block

The first step the nanoLC must do is check the water level in the tank to “decide” if the water valve should be turned ON or OFF. This is accomplished through a Decision block and a sensor connected to input I0 (or in our example application, a switch connected to input I0).

1. Click the “Decision” icon on the tool bar.
2. Use the mouse to position the cursor in cell A1. (Note that the cursor changes shape). Click the mouse button to “drop” a decision block in the cell.
3. Double-click the Decision block in cell A1 to open the “Decision Block” dialog box.

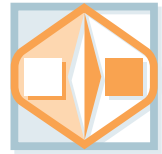

The various configuration dialog boxes can also be opened by right-clicking the block and clicking the “... Configuration” option.

4. Enter data in the various fields in the dialog box as shown in Figure 1-6. Click the “OK” button when finished.

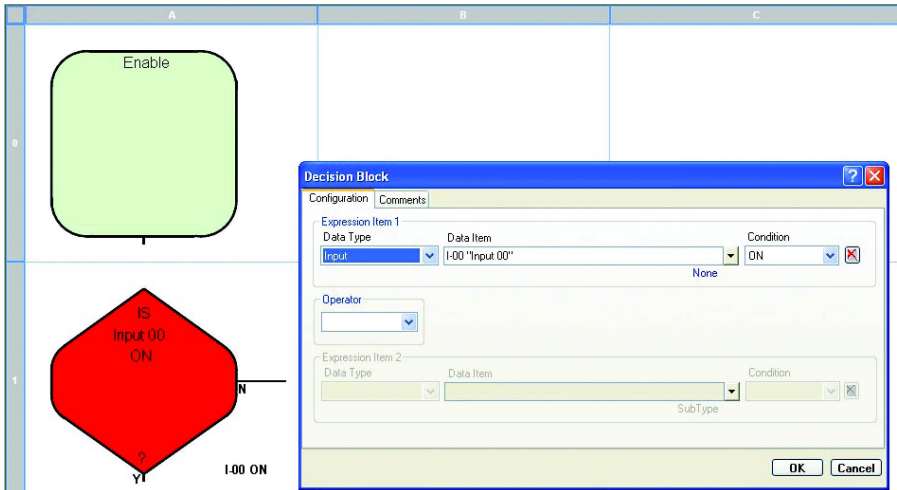

Figure 1-6 “Decision Block” dialog box for cell A1

1.3.2 Cell A2 – Control Block

The Decision Block asks the question, “Is INPUT 0 ON?” If the answer is yes (Y), the nanoLC should turn the water inlet valve off to stop the tank from filling. This is accomplished through the use of a Control block. Note that each possible answer to the question requires a separate control block.

To enter a control block:

1. Click the “Control” icon on the tool bar to select it.
2. Use the mouse to position the cursor in cell A2. (Note that the cursor changes shape). Click the mouse button to “drop” a Control block in the cell.
3. Double-click the Control block in cell A2 to open the “Control Block” dialog box.
4. Enter data in the various fields in the dialog box as shown in Figure 1-7. Click the “OK” button when finished.

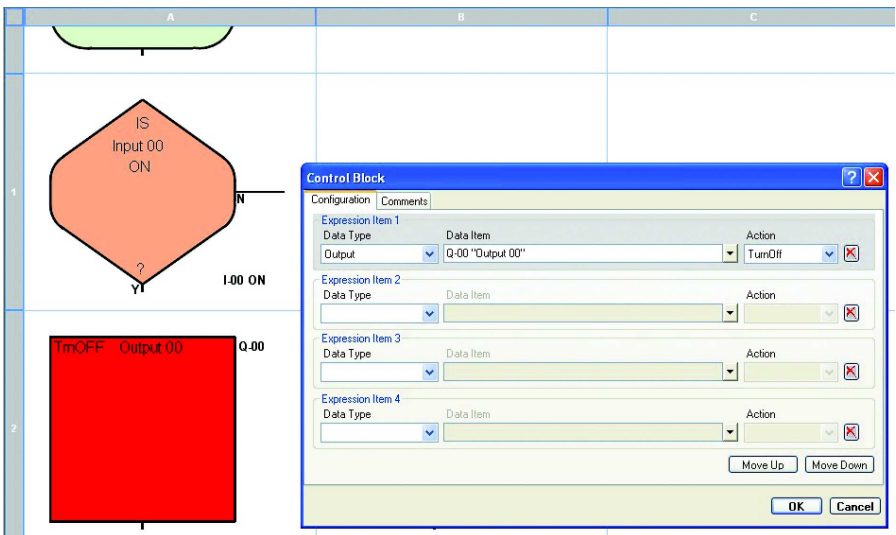
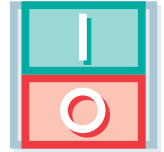

Figure 1-7 “Control Block” dialog box for cell A2

1.3.3 Cell B2 – Control Block

The Decision Block asks the question, “Is INPUT 0 ON?” If the answer is no (N), the nanoLC should open the water inlet valve to fill the tank. This is accomplished through the use of a Control block. Note that each possible answer to the question requires a separate control block.

To enter a control block:

1. Click the “Control” icon on the tool bar to select it.
2. Use the mouse to position the cursor in cell B2. (Note that the cursor changes shape). Click the mouse button to “drop” a Control block in the cell.
3. Double-click the Control block in cell B2 to open the “Control Block” dialog box.
4. Enter data in the various fields in the dialog box as shown in Figure 1-8. Click the “OK” button when finished.

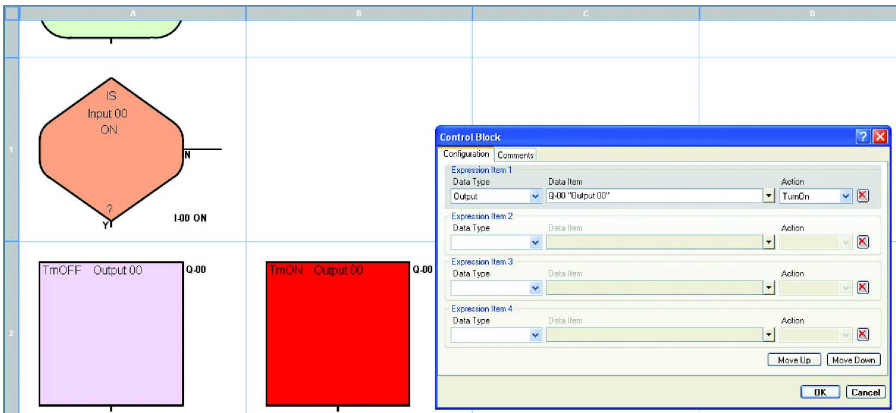

Figure 1-8 “Control Block” dialog box for cell B2

1.3.4 Message for the Operator Panel

The nanoLC's Operator Panel displays a message with the state of the water inlet valve, either ON or OFF. To accomplish this a message is created, and then the message is placed in a Message block on the flow chart at the desired display point.

1. Click the "View...Messages" menu to open the Message Editor. The Message Editor creates messages of 4 lines with 20 characters each.
2. Select the "MI-00, Display Message 00" from the "Current Message" drop-down menu (see Figure 1-9). This is the message title ①.
3. Click on the desired character block (line 2, block 4), and type the text "Inlet Valve is" to enter the message content ②.
4. To insert a data field, such as the status of Output Q0, "Q-00" in our example:
 - a) Click on the desired character block (line 3, block 7) at the desired location, the start of "Q-00" ③.
 - b) From the "Type" drop-down menu, click the "Outputs" option ④.
 - c) From the "Data Item" drop-down menu, click the "Q-00 Output 00" option ⑤.
 - d) Select the "Insert" button ⑥.
5. When finished click the "Save" button ⑦, and then click the "Close" button ⑧.

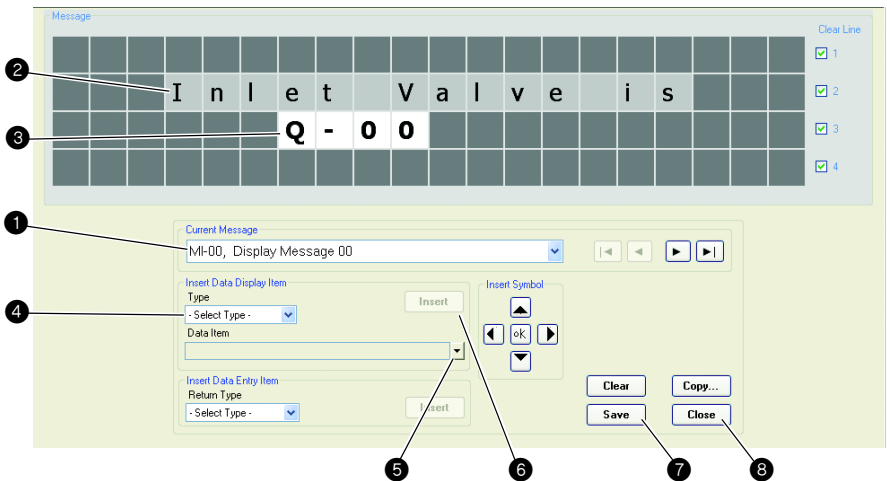

Figure 1-9 Message Editor

1.3.5 Cell A3 – Message block

After the message is created, it must be added to the flow chart at the appropriate location.

1. Click the “Message” icon on the tool bar.
2. Use the mouse to position the cursor in cell A3. (Note that the cursor changes shape). Click the mouse button to “drop” a Message block in the cell.
3. Double-click the Message block in cell B2 to open the “Message Block” dialog box.
4. Enter data in the various fields in the dialog box as shown in Figure 1-10. Click the “OK” button when finished.

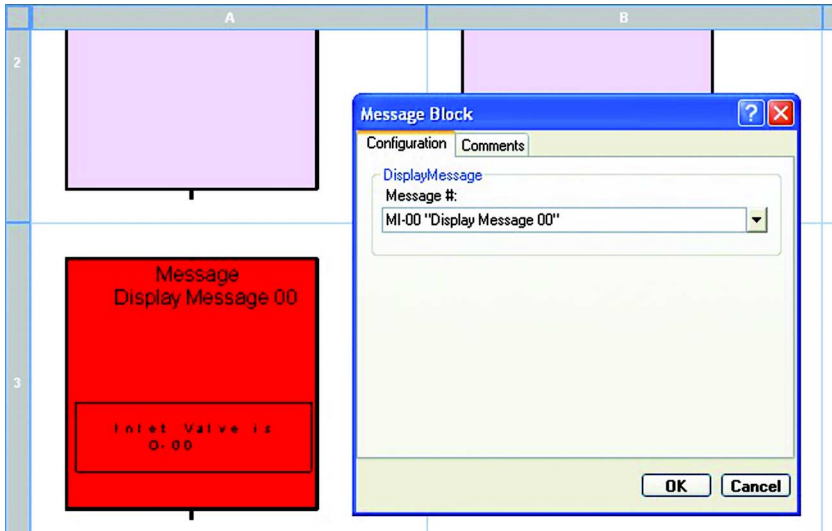

Figure 1-10 “Message Block” dialog box for cell A3

1.3.6 Connecting Blocks

To complete the flow chart the connecting lines must be added to the flow diagram.

1. Move the cursor over the connection point of cell A0 and click once. To indicate proper location, a color change occurs when the cursor is in the correct location (Figure 1-11).

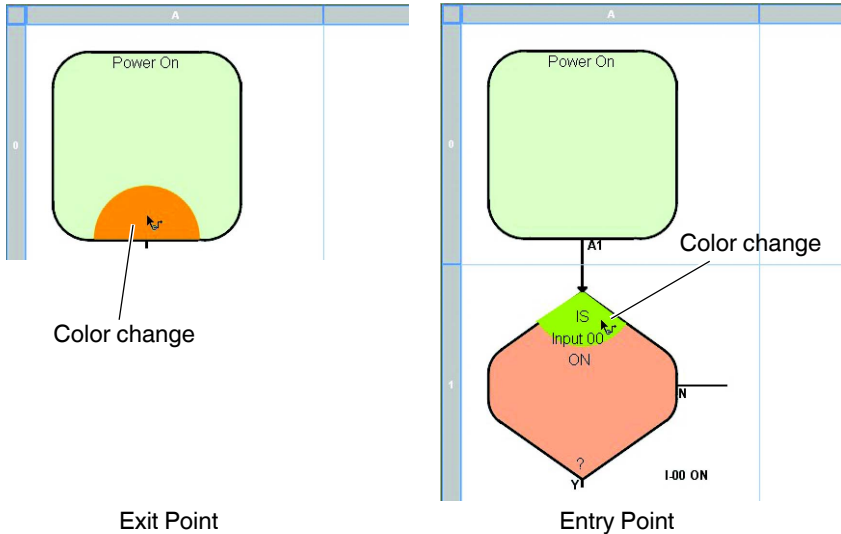

Figure 1-11 Exit and entry connection points



Connecting lines are directional. Always click on the exit point (bottom or right side) of a block before click the entry point (top) of the next block.

2. Move the cursor over the connection point of cell A1 and click once. The color change indicates correct location (Figure 1-11). Cells A0 and A1 are now connected.
3. Continue connecting the cells through the remainder of the flow chart
 - A1 (Yes) to A2
 - A1 (No) to B2
 - A2 to A3
 - B2 to A3
4. Connect the bottom of cell A3 to the top of A1. When finished, the flow chart should look like Figure 1-12.

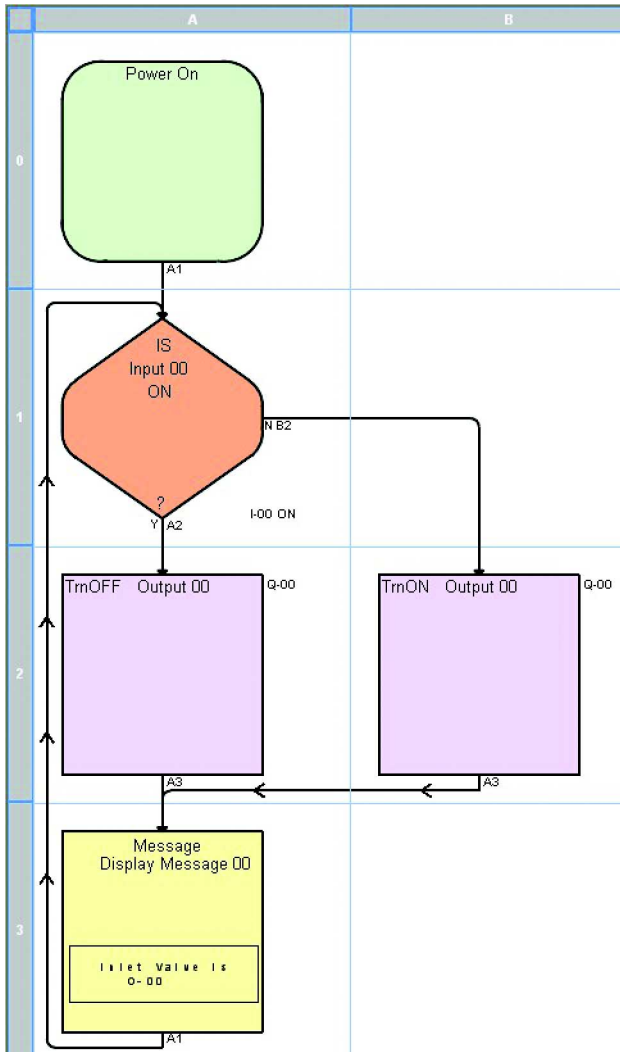

Figure 1-12 Finished flow chart



Hints:

- The + and – icons on the tool bar zooms in and out on the flow chart.
- To remove a connecting line, click on the line and press the Delete key.

1.4 Running the Project

To run the project on the nanoLC, it must be downloaded to the controller.

1. Click the “nanoLC... Download & Go” menu.



The “Download & Go” function downloads the project to the connected nanoLC, begins execution of the project on the connected nanoLC, and opens the “nanoLC Monitor” window in nanoNavigator.



Download & Go will stop any project currently running on the nanoLC and overwrite it.



The “nanoLC... Download” command downloads the project without running it or starting the “nanoLC Monitor” window.

At this point the project is running. Using the switch at input I0, you should be able to cause the LED at Output Q0 to turn ON or OFF. The message on the nanoLC display should also show the status of the output.

The “nanoLC... Monitor” window highlights the flow chart blocks as the nanoLC executes the project. nanoNavigator displays the different execution paths as the simulator switch is turned ON and OFF.

1.5 Additional Information

This Quick Start has provided step-by-step instructions for creating a simple flow chart. There are additional block types that can be used, different types of I/O and connectivity options available on the nanoLC family of controllers. Additional information can be found in the User Manuals for these products.